



DPD

Programmable
Direct Current Display

USER'S MANUAL

September 1990

No. 601-702-00 A

Table of Contents

Introduction	1
Description	1
Calibration	4
Installation	8
Operation	13
Maintenance	15
Troubleshooting	15

48^{HR.} DELIVERY



United States/Canada
TOLL FREE
1-800-999-2900

16650 Schoenborn Street
Sepulveda, California 91343, U.S.A.
Tel: (818) 894-7111 • Tlx: 65-1322
FAX: (818) 891-3297
CONNECT (MacNet): MIISEPULVEDA

United Kingdom
FREE PHONE
0800 525107

18 Royce Road, Crawley
W. Sussex RH10-2NX, United Kingdom
Tel: 0293 514488 • Tlx: 87667
FAX: 0293 36852

Australia
TOLL FREE
008 251928

3/18 Resolution Drive, Caringbah
New South Wales 2229, Australia
Tel: (02) 525-9177 • Tlx: 790-75914
FAX: (02) 525-7296

Ask for the STAR Center

Moore Industries' STAR[®] Center has a wide variety of quality instrumentation in stock and ready to ship.

- Signal Transmitters
- Temperature Transmitters
- P/I and I/P Converters
- Isolators and Converters
- Indicators and Displays
- Alarm Trips
- Integrators and Totalizers
- Power Transducers
- Instrument Power Supplies
- Racks, Rails and Enclosures

Most instruments can be customized to meet your needs. Even then, you'll never have to wait more than a few days.

Moore Industries

STAR
CENTER

* Support, Technical Assistance, and Repair (our Quick-Ship Facility)

Introduction

Moore Industries' Programmable Direct Current Display (DPD) is a compact, panel-mount meter that measures dc voltage or current and digitally displays a representative value.

This manual contains calibration, installation and operation information for the DPD. The Notes, Cautions, and Warnings contained in this manual are provided to avoid minor inconveniences, equipment damage, or personal injury while calibrating or installing this device.

Description

The DPD is a highly reliable instrument designed to measure voltages in the range of 0 to 10 volts dc, or current in the range of 0 to 20 mA. It then displays a representative value for the voltage or current readings in percentage or engineering units.

This meter is powered by an external 115 or 230 Vac source. A switch on the main PCB of the unit allows the user to select the appropriate ac power setting.

The DPD is packaged in a sturdy, light-weight plastic housing that mounts directly on a panel in a user-provided cutout. Mounting hardware is provided with each unit.

All DPD's are equipped with a 4-digit display, which provides the readout of the voltage or current being measured. This display also shows error messages when conditions warrant such an indication.

The controls on a standard DPD consist of the SET and ENTER pushbuttons, and the PROCESS/SCALING and mA/V DIP switches. These controls

allow the user to select the type of process signal to be measured and to calibrate the DPD.

The DPD is also available with factory-configured options; the FS6, C, and TX options. Each of these options are described in the following subsection.

Table 1 contains the equipment specifications for the standard DPD.

Configuration Options

FS6 Option. Allows the DPD to accept inputs from as many as six devices. A rotary switch on the front panel allows the user to select which input will be displayed. Units equipped with this option also have a second terminal block to connect the additional devices. (This option not available with C Option.)

C Option. Provides a single trip point alarm that energizes a Form C relay. This relay is rated for 0.5 A at 120 Vac, non-inductive. Units equipped with the C Option feature an ALARM LED and pushbuttons on the front panel for programming the alarm trip point. (This option not available with FS6 Option.)

TX Option. Provides a transmitter excitation power supply that may be used to drive 2- and 4-wire transmitters. This 24-Vdc, 25-mA power supply is contained on one internal PC board.

Serial Number. A complete history is kept on every product Moore Industries sells and services. This information is keyed to the unit's serial number. Whenever service information is required on a particular product, it is necessary to provide the factory with the serial number of the unit. The serial number for the DPD is located on a label affixed to the top of the housing.

Table 1. DPD Equipment Specifications

Characteristic	Specification
Input Range	0-20 mA 0-10 Vdc
Display Range	-999 to 9999 (user-scaleable) Sensitivity: Maximum, 200 μ V/count or 0.4 μ A/count; Minimum: 1 count
Power Requirements	115/230 Vac (\pm 10%), 60/50 Hz (switch-selectable)
Accuracy	0.02% reading, \pm 1 count
Repeatability	\pm 1 count
Stability with Temperature	Zero: 0.1 ppm/ $^{\circ}$ C; Span: 0.01% reading/ $^{\circ}$ C
Stability with Time	10 counts/year, maximum
Noise Rejection	Normal Mode Rejection Rate (NMRR): \geq 60 dB @ 50/60 Hz, \pm 0.1 Hz Common Mode Rejection Rate (CMRR): \geq 120 dB @ 50/60 Hz, \pm 0.1 Hz with 250 Ω unbalance
Overload Protection	Power lead to ground: 1500 Vdc or Vac rms; across inputs Voltage: Up to 250 Vdc or Vac for one minute, V+ to V- Current: Up to 150 mA dc or ac for one minute, I+ to I-
Input Impedance	Voltage: 1 M Ω ; Current: 5 Ω
Read Rate	Two/second, nominal
Display	Each digit is seven-segment red/orange LED, 14.2 mm (0.56 in.) high
Environmental Conditions	Operating: 5 to 45 $^{\circ}$ C (41 to 113 $^{\circ}$ F) Storage: -40 to 65 $^{\circ}$ C (-40 to 149 $^{\circ}$ F) Humidity: \leq 80% relative humidity (non-condensing)
Weight	454 grams (1 lb.)
NOTE: Refer to the Installation Section for physical dimensions.	

Model Number. Moore Industries' model numbers identify the type of instrument, functional characteristics, operating parameters, any options ordered, and the housing type of the unit. If all documentation for a unit is missing, the model number can be used to obtain configuration information about the DPD. The model number for the DPD is located on the same label as the serial number, which is affixed to the top of the unit.

The example below identifies the significance of each field in the DPD model number. The following paragraphs describe the entries found in a typical DPD model number.

Type Unit – This field specifies the model designation of the unit. For this unit, the designation is **DPD**.

Input – This field specifies the input range of the unit as it comes from the factory. This field will contain the desired input within 0-20 mA or 0-10 V (e.g., **4-20MA, 0-5V, 1-5V**)

Display Range – This field specifies the display range corresponding to the user-specified input as it comes from the factory. For example, **0-4500**.

Power – This field specifies the ac power required for the unit as it comes from the factory. This field will contain either **115AC** or **230AC**.

Option(s) – This field specifies the option(s) with which the DPD is equipped as it shipped from the factory. This field may contain **-FS6, -C, or -TX**.

Housing – This field specifies the type housing in which the DPD is enclosed. This field will contain **P** for plastic housing.

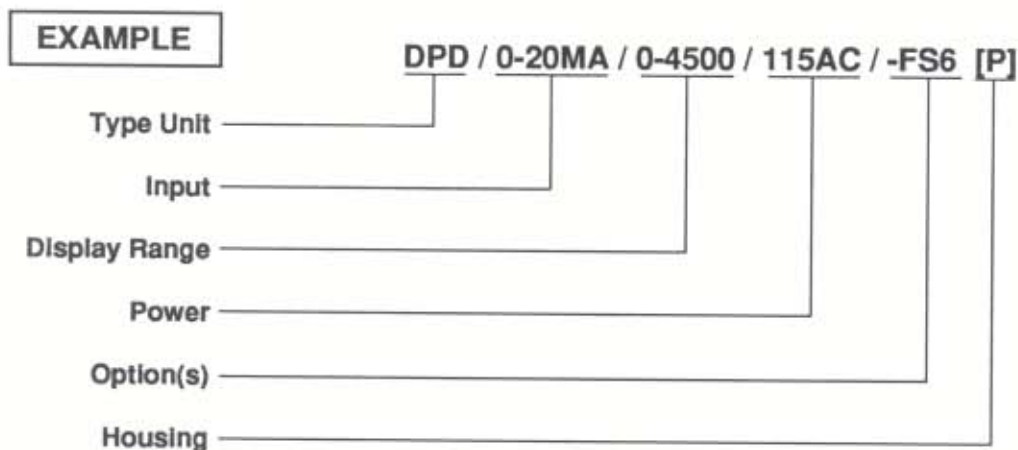

DPD

Calibration

Calibrating the DPD requires the simulation of two input values; the anticipated lowest and highest. To complete the calibration, all controls and indicators of the standard unit are used.

The controls for the standard DPD are behind the front lens. The lens snaps into place and is removed with a small slotted-head screwdriver. A narrow cutout at the bottom of the lens is provided to gently pry it off. Figure 1 shows the location of the standard DPD controls.

The digital display is the only visual indicator on the standard unit. It displays the voltage or current measurements, as well as error messages.

The SET and ENTER pushbuttons are used to calibrate the DPD and to clear error messages.

The PROCESS/SCALE DIP switch (1) is used to set the unit to the normal operating mode or to the calibration mode. This switch will be either a rocker or a slide switch.

The mA/V DIP switch (2) is used to select the type input the DPD is to measure; current or voltage. This switch will be either a rocker or a slide switch.

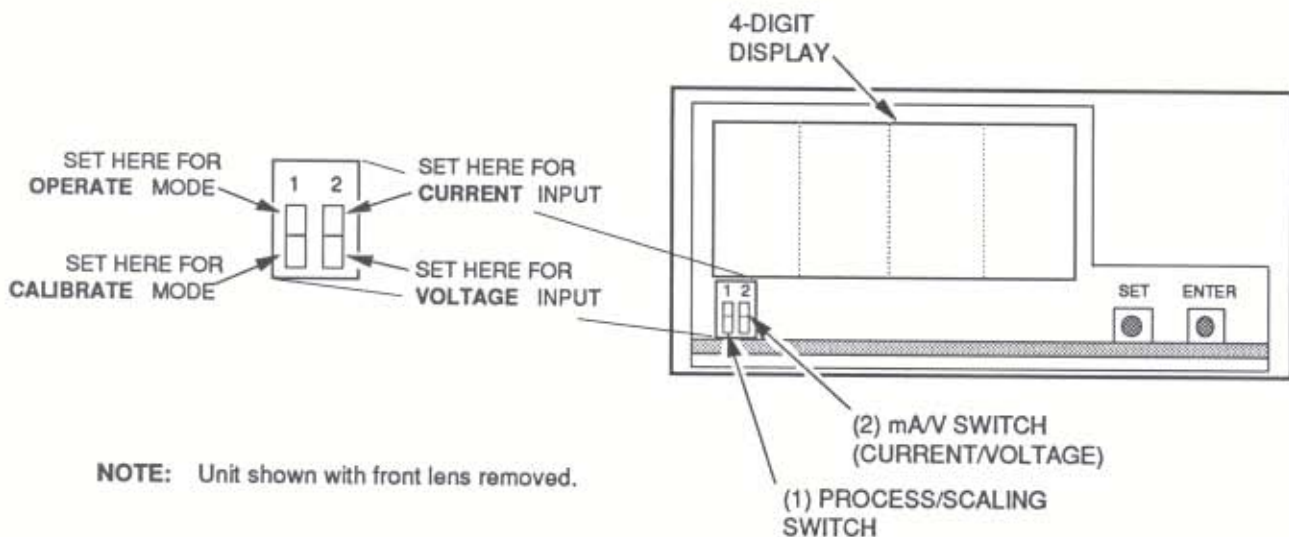

Figure 1. Standard DPD Controls

Accessing the Electronics

On standard DPD's, the controls are accessible by removing the front lens. But to change the ac selection or to perform some functions required by configuration options, the electronics will need to be removed from the housing.

The DPD electronics form a single assembly. This assembly is held in the plastic housing by a built-in retainer on the inside-bottom surface of the housing. This retainer is visible from the front of the unit when the lens is removed.

To remove the electronics: first, the front lens must be removed; and second, the sides of the housing by the front opening must be squeezed so the opening bows just enough so the electronics can clear the built-in retainer. When the electronic assembly clears the retainer, it can be pulled out the front of the housing.

AC power should always be removed from the unit when attempting to remove the electronics. It is possible to remove the electronics without physically disconnecting the wires from the rear terminals.

AC Power Configuration

The DPD is factory-configured to user-specifications. These specifications include the type of ac power that is intended for the unit. If the power available for the DPD is different than when initially ordered, the user may change the ac configuration.

A slide switch on the Main PCB is used to select either 115- or 230-Vac operation. To access this switch, the Main PCB must be removed from the housing (the entire electronic assembly).

Figure 2 shows the location of the ac selection switch on the Main PCB. The 115V and 230V positions are marked on the PCB. Simply slide the switch to the desired position. Once the selection is made, the electronics should be carefully pushed back into the plastic housing until they lock behind the built-in retainer.

Calibration Setup

To calibrate the DPD, an adjustable dc voltage or milliamp (current) source with an accuracy of 0.02% or better is required. The particular input type required is based on the application of the DPD. Along with an input source, a Phillips-head screwdriver and an ac power source are also required to calibrate this device.

Figure 3 shows the equipment setup required to calibrate the DPD. See figure 7 in the Installation Section for terminal assignments.

The following calibration procedures may be performed on a workbench or with the DPD mounted in its intended operating location.

WARNING

The ac power terminals at the rear of the DPD are exposed. To avoid electrical shock, remove ac power before rewiring and avoid contact with exposed terminals while power is applied.

Standard DPD Calibration Procedure

1. Remove front panel lens and set mA/V (current/voltage) DIP switch to the desired input type.
2. Connect the DPD as shown in figure 3. Ensure proper input type is used.
3. Set PROCESS/SCALING switch to SCALING. ('Lo' will appear in digital display.)
4. Set input source to anticipated lowest value to be measured (e.g., 4 mA).

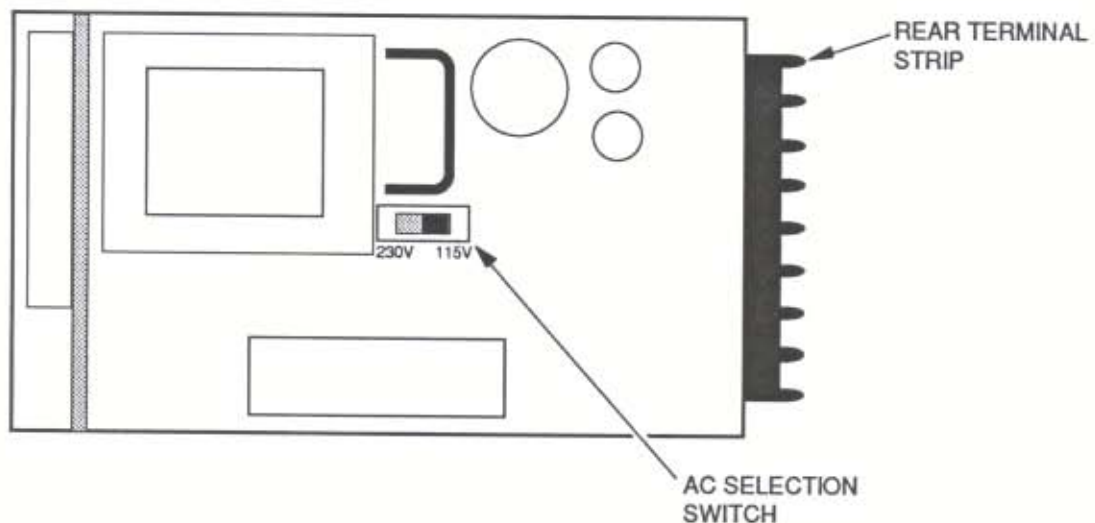
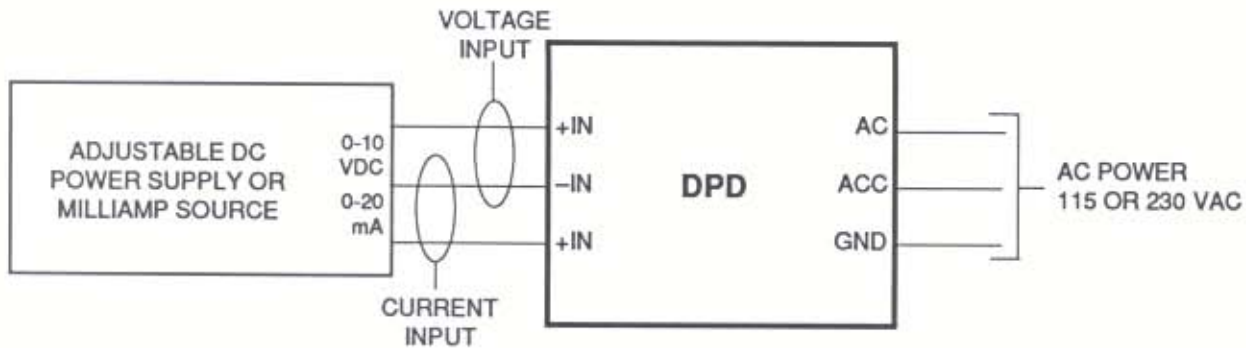

Figure 2. 115/230 Vac Selection Switch Location (Main PCB)



- NOTES:** 1. Either a voltage or current input source may be applied, but not both. The -IN terminal is common to both inputs.
2. See figure 7 for the DPD terminal pin assignments.

Figure 3. DPD Calibration Setup

5. Press ENTER pushbutton to display existing value.
6. Repeatedly press SET pushbutton to change (scroll) value of flashing digit.
7. With flashing digit is at desired setting, press ENTER to move to next digit. Repeat steps 6 and 7 until all digits are set.
8. With last digit still flashing, simultaneously press SET and ENTER pushbuttons to register displayed value in DPD memory.

NOTE

While the DPD is registering this entry, 'oo' will appear in the display. After a few seconds, it will display either the next entry to be set or an error message.

9. With 'Hi' displayed, change input to simulate full-scale setting (high) (e.g., 20 mA).
10. Repeat steps 5 thru 8 to set digits to represent the high display value (e.g., 7500). When complete, decimal points error message will appear.

11. With four decimal points displayed, press ENTER.
12. When only one decimal point is displayed, press SET pushbutton until desired position is obtained.
13. Simultaneously press SET and ENTER pushbuttons to register decimal point position in DPD memory. 'Lo' will appear in digital display.
14. Return the PROCESS/SCALING switch to the PROCESS position for normal operation.

Pressing both the SET and ENTER pushbuttons simultaneously causes the DPD to recalibrate itself to the applied input and represent that input with the value displayed at that moment. As a protective measure, if scaling changes are made but are not terminated in the manner described in the procedures above, the DPD will not register the new values and the previous values will remain. The SET and ENTER pushbuttons are not functional unless the PROCESS/SCALING switch is in the SCALING position.

Calibration Considerations for DPD Options

Units configured with the FS6 or C Options require additional attention during calibration beyond that required for standard units.

FS6 Option. Each input to a unit configured with the FS6 Option must be of the same signal type; voltage or current. Also, each signal must be of the same measurement range.

For units configured with this option, each channel should be checked by connecting an input signal to it and setting the front panel rotary switch so the corresponding channels can be viewed. After calibrating the DPD with an input on channel 1, the same input should be used on channel 2, then 3, and so on. The display reading for each channel should be identical.

See figure 8 in the Installation Section for terminal assignments

C Option. Along with completing the standard calibration procedure, units configured with the C Option also require the user to select the high- or low-alarm functions and to set the alarm trip point.

Before setting the trip point, the high- or low-alarm function must be selected (or verified). A removable jumper is used for this selection. The jumper pins on the Alarm PCB are marked with "HI" and "LO". A jumper is used to connect two of the three pins for the desired selection. (The center pin is common to both high and low.)

To access this jumper, the electronics must be pulled out of the housing at least one inch. Refer to Accessing the Electronics subsection presented earlier in this section for information on accessing the Alarm PCB.

Figure 4 shows the location of the jumper pins, and the required connection for the desired selection.

Once the jumper is set, the electronics should be carefully slid back into the plastic housing until they lock behind the built-in retainer.

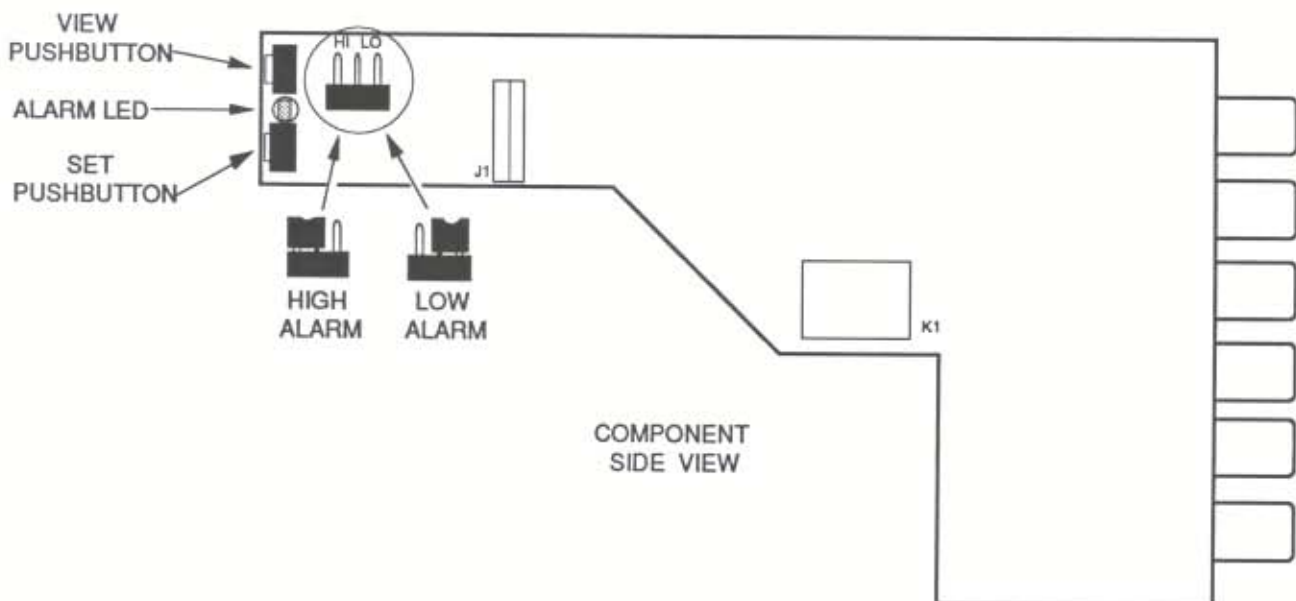

Figure 4. High/Low Alarm Jumper Location

DPD

After the DPD is configured for high or low alarm, the alarm trip point must be set. The SET and VIEW pushbuttons on the front panel are used to set the alarm trip point.

To set and verify the alarm trip point, the DPD must be setup for calibration as shown in figure 3. Using an adjustable input allows for verification of the trip point setting.

There are two ways of verifying the response of the alarm option; one is the action of the ALARM LED, and the other is the reaction of the alarm relay. An ohmmeter is required to monitor the reaction of the relay contacts. (See figure 9 in the Installation Section for C Option terminal assignments.)

The ALARM LED illuminates when an alarm condition is detected. It extinguishes when the alarm condition no longer exists. If the alarm override option is used, the LED will not illuminate, nor will the alarm relay change states, when the trip point is exceeded.

To set the alarm trip point, perform the following procedure.

1. If unit is set for high alarm, set input to a value slightly less than the desired trip point.

If unit is set for low alarm, set input to a value slightly higher than the desired trip point.
2. Press and hold VIEW pushbutton to verify current trip point setting.
3. Simultaneously press SET and VIEW pushbuttons. The current trip point setting will appear with first digit flashing.
4. Press SET pushbutton to sequence (scroll) first digit to desired setting.
5. Press ENTER pushbutton to move to next digit.
6. Repeat steps 4 and 5 until last digit is set.
7. Simultaneously press SET and VIEW pushbuttons to register trip point setting.

8. Vary adjustable input in the appropriate direction to surpass trip point setting. Verify that ALARM LED illuminates when trip point is exceeded, and extinguishes when trip point is no longer exceeded.

If ac power is removed from the DPD, the trip point setting will remain where last set. If the latest trip point setting is not registered by simultaneously pressing the SET and VIEW pushbuttons, the previous setting will remain.

Installation

Installing the DPD consists of physically mounting the unit and completing the necessary electrical connections. Each of these tasks are described separately in the following subsections.

Mounting the DPD

The DPD is designed for mounting in a flat panel cutout. Figure 5 contains the outline dimensions of the DPD. Figure 6 contains the cutout dimensions required to mount one, two, three, or four panel-mount meters in cutouts of varying height. The necessary mounting hardware is supplied with each unit.

The cutouts shown in figure 6 afford the user a couple of mounting options. If only one meter is to be mounted, the single cutout dimensions should be used. However, if stacking meters in a vertical arrangement is desirable, then a double, triple, or larger cutout is required. Regardless of how many DPD's are mounted in a single panel cutout, the maximum panel thickness should not exceed 9.5 mm (0.375 inch).

If DPD's are stacked in a vertical cutout, the front panel of each meter will rest slightly on the meter beneath it. Removal of the front lens may be more difficult with the front panels in such close proximity.

After selecting and making the appropriate cutout, perform the following steps to physically mount the DPD.

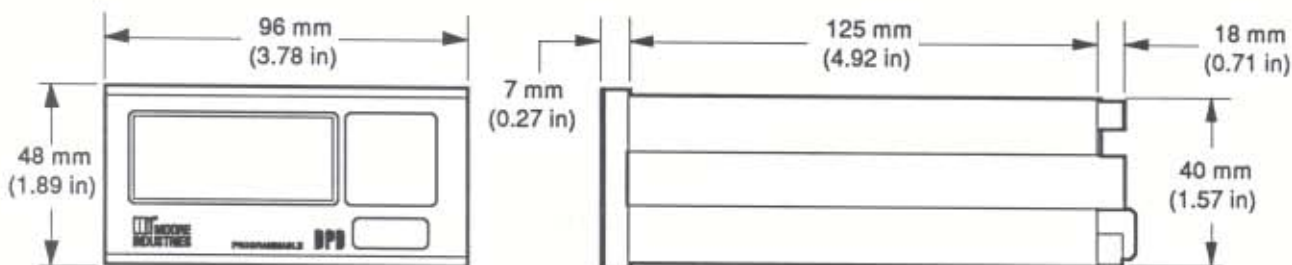

Figure 5. DPD Outline Dimensions

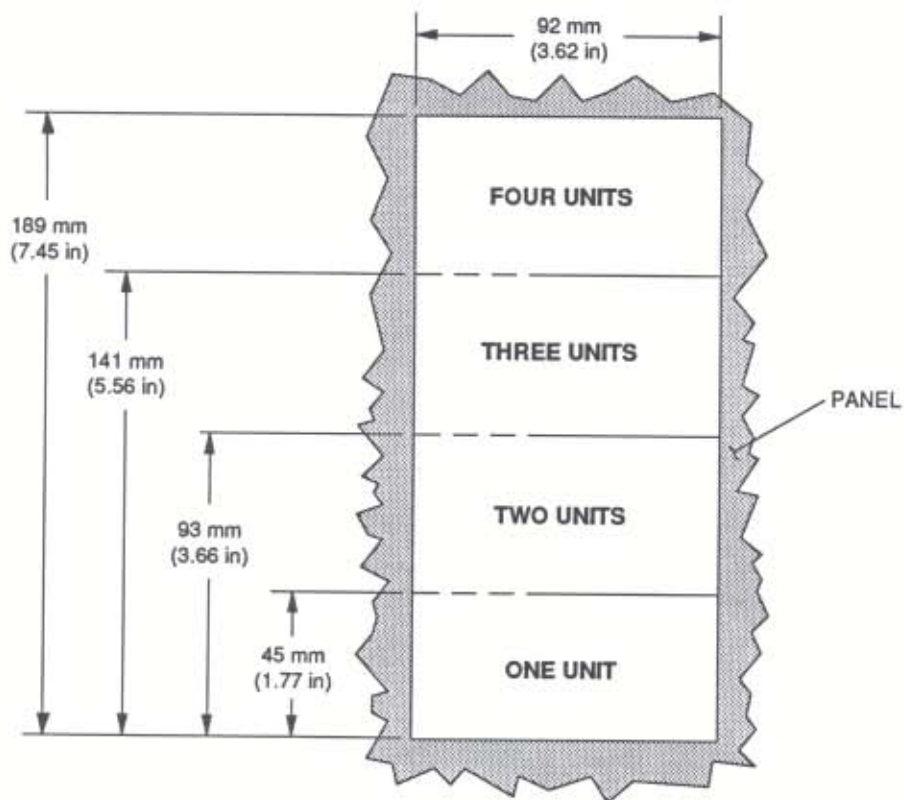

Figure 6. Panel Cutout Dimensions

DPD

- Using a small Philips-head screwdriver, remove mounting bracket from unit by removing two screws at rear of unit securing bracket to housing.

NOTE

Units equipped with the FS6 Option require removal of the additional connector to remove the mounting bracket. Two screws secure the connector to the housing.

- From front of mounting panel, slide unit through cutout until flange around front panel is against edge of cutout. (Ensure unit is right-side-up.)
- Reposition mounting bracket on rear of meter and secure with two Philips-head screws.

CAUTION

Over-tightening bracket screws or mounting the meter in a panel that is too thick may cause the housing to distort or crack.

- If meters are being stacked vertically, repeat steps 1 through 3 for each meter. Place first meter at lowest point of cutout.

Standard Unit. The electrical connections are made to an 8-location terminal strip at the rear of the DPD. Figure 7 shows the electrical connections required for the standard DPD.

Terminal lugs may be used to complete the electrical connections, but are not supplied with the unit.

Ensure that ac power is removed from the unit while electrical connections are being made. All connections to the DPD should be completed before supplying ac power.

FS6 Option. The FS6 Option allows for six inputs to be applied to and measured by the DPD. This option includes a quick-disconnect terminal block to complete the additional input wire connections.

The additional terminal block mates with the FS6 printed circuit board at the upper rear of the DPD. It is secured to the housing with two Philips-head screws; one at each end.

Individual wire connections are made by inserting the uninsulated end of a wire in to the appropriate opening and tightening the corresponding compression screw. Polarity for each connection is marked on the terminal block. The input terminals are marked "IN1" through "IN6." See figure 8.

The OUT terminals of the FS6 terminal block are used to apply the selected input to the standard input terminals. The OUT terminals will reflect whichever input has been selected by the front panel selector knob.

Electrical Connections

The electrical connections required for the standard unit, FS6 Option, C Option, and TX Option are described in the following paragraphs

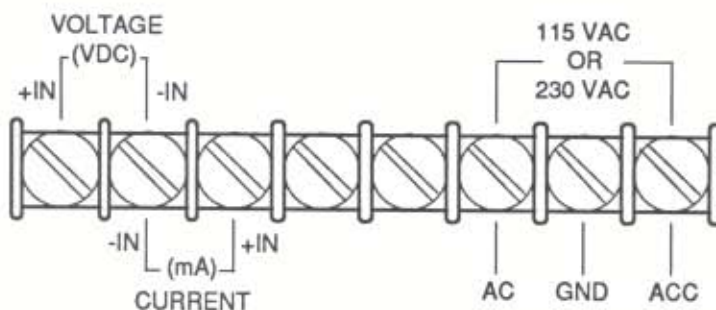

Figure 7. Standard DPD Electrical Connections

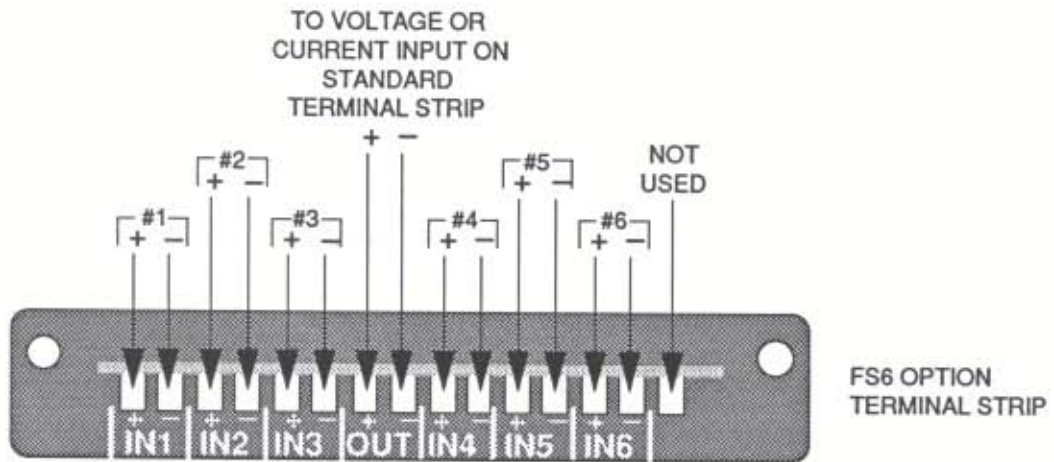

Figure 8. FS6 Option Electrical Connections

If the FS6 option will be used to switch current-loop type inputs, it is necessary to install diodes on each channel to maintain loop continuity should the channels be disengaged. Diode 1N4004 (MII P/N 800-4004-11) is suitable for this purpose. They can be installed directly on the FS6 terminal block (one diode for each channel) or soldered on pads provided on the FS6 PCB. Figure 9 shows the location of the pads and the correct polarity for connecting the diodes.

C Option. The C Option provides a single pole, double throw alarm relay that de-energizes when the input exceeds the user-selected trip point.

Connections for the C Option are made at the upper rear of the DPD on blade terminals. Female connector lugs are supplied with this option to make the appropriate connections for the C Option. Figure 10 illustrates the connections for the C Option.

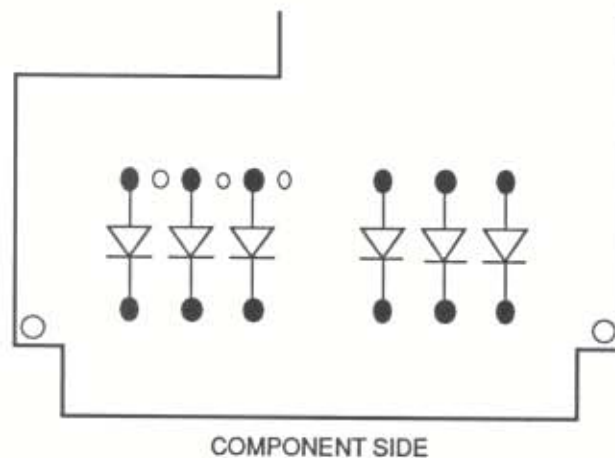

Figure 9. Loop Continuity Diode Locations (FS6 PCB)

DPD

A crimping tool, which is user-supplied, is required to crimp the lugs to the wires. Thomas & Betts WT1300 Crimping Tool, or equivalent, is required to properly crimp the lugs to the wires.

The relay override connection may be used to prevent the relay from de-energizing and the front panel LED from illuminating should an alarm condition exist. A simple toggle switch may be used to override the relay's change of states, which can be used to acknowledge or silence alarms that otherwise would be maintained by the change in contact states.

TX Option. The TX Option provides a 24 Vdc, 24 mA excitation source for either a 2-or 4-wire transmitter. The transmitter in turn provides the input signal to the DPD.

All electrical connections for the TX Option are made at the standard terminal strip, at the rear of the unit.

Figure 11 shows the electrical connections for the TX Option. Figure 12 shows the electrical connections required when using the DPD with the TX Option to power a 2-wire transmitter.

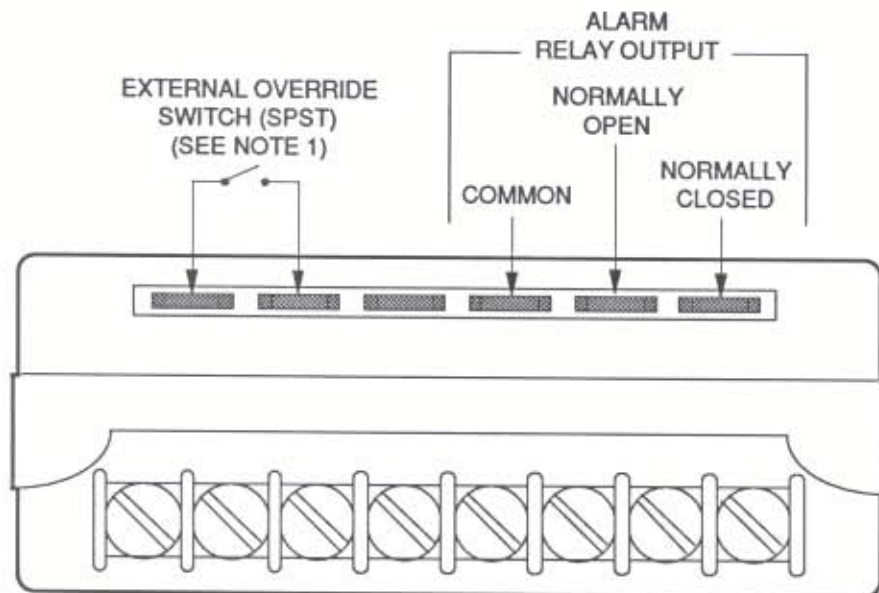

- NOTES:**
1. With override switch closed, Alarm Relay is inhibited from changing states.
 2. The alarm option connections are made to slide-on spade lugs.

Figure 10. C Option Electrical Connections

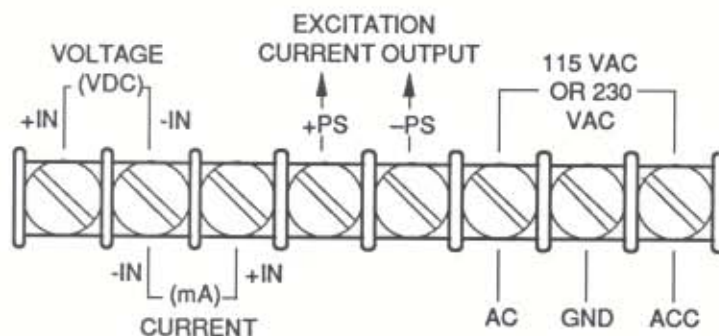

Figure 11. TX Option Electrical Connections

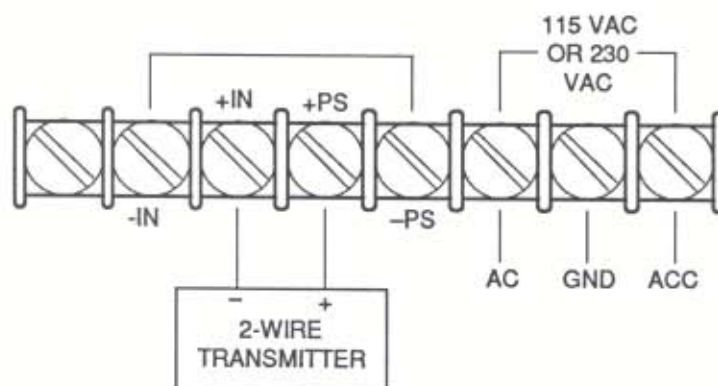

Figure 12. TX Option Used with 2-wire Transmitter

Operation

Once the standard DPD is calibrated and installed, it will reliably measure current or voltage inputs and display a representative numerical value or an error message. The numerical value will be within the range established during calibration. Error messages will appear during calibration or normal operation to indicate unacceptable programming parameters or operating errors. (Refer to the Troubleshooting Section for an explanation of error messages.)

Figure 13 shows the front panel of the standard DPD.

Using the FS6 Option

The FS6 Option features a rotary dial on the front panel with numbered markings for each of the six inputs. See figure 14. The digital display will show the corresponding reading for the input selected or an error message for that particular input.

The selected input will be available at the OUT terminals of the FS6 terminal block. From these terminals the signal is connected to the input of the standard terminal strip.

DPD

Using the C Option

Once the alarm trip point is set, the ALARM LED on the front panel will illuminate when an alarm condition is detected. It will automatically extinguish when the alarm trip point is no longer exceeded.

If an override switch is wired to the Alarm PCB, the alarm relay can be inhibited from changing states and the ALARM LED from illuminating, even if an alarm condition exists.

The alarm option uses the SET and VIEW pushbuttons to set and view the alarm trip point. To view the current trip point value, press and hold the VIEW pushbutton. When the VIEW pushbutton is released, the display returns to the measurement mode. See figure 15.

The Calibration Section contains procedures for setting the alarm trip point and configuring the DPD to respond to a high or low alarm condition.

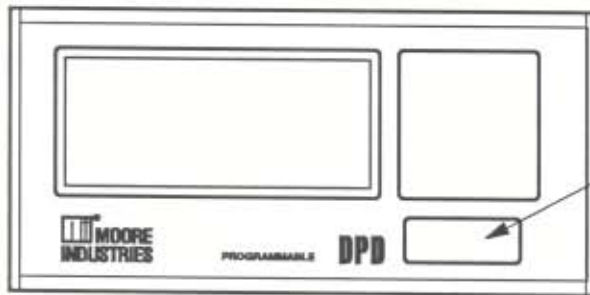

Figure 13. Standard DPD Front Panel

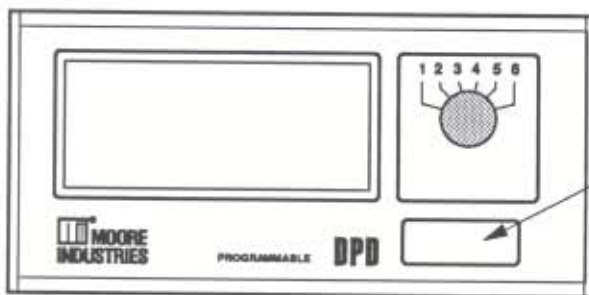

Figure 14. FS6 Option Front Panel

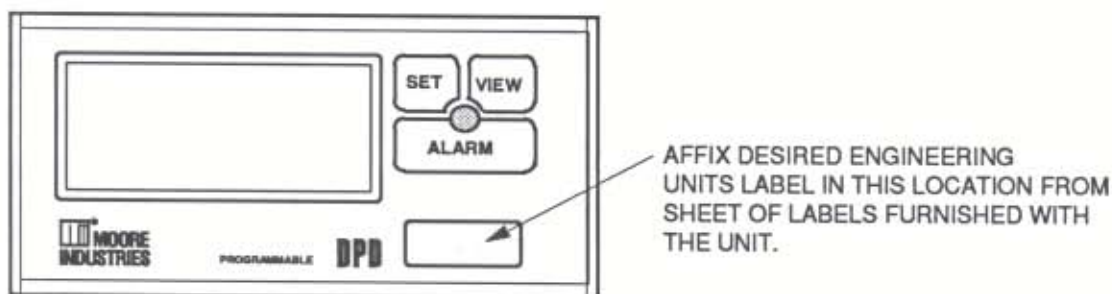

Figure 15. C Option Front Panel

Maintenance

Field maintenance for the DPD is limited to keeping the electrical terminals clean and secure. Each unit should be visually inspected at least once every six months to ensure the terminals free of dirt and oxidation, and the electrical wires are in good condition.

For reliable operation, frayed wires should be replaced as soon as possible with appropriate electrical wire and lugs (if used).

Each terminal should be checked with a screwdriver to ensure that the connections have not become loose over time. When inspecting the rear terminals, avoid contact with the ac power terminals. Anytime the DPD is to be handled, it is wise to remove ac power.

Troubleshooting

Another valuable feature of the DPD is that it displays error messages in response to programming or operational errors. These error messages are very helpful in troubleshooting the DPD. Tables 2 and 3 contain the error messages that may appear during calibration and operation, respectively.

If the performance of a DPD is suspect, the unit should be setup for calibration as described in the Calibration Section of this manual. The calibration setup allows for the user to apply controllable, known inputs to the unit to achieve predictable results.

If a problem persists with the DPD, the user should contact Moore Industries' Customer Service Department by dialing 1-800-999-2900 for technical assistance. Or contact your local sales representative.

Table 2. Calibration Error Messages

Message	During Calibration	
	Cause	Cure
Err1	Slope error. Same values entered for both 'Lo' and 'Hi'.	'Lo' and 'Hi' values must be different. Press SET pushbutton and re-enter these values.
Err 2	Slope error. Too many display counts for an input voltage or current that is too low.	Press SET pushbutton and reduce the number of display counts for the given input. (Example: reduce 700.0 to 700)
OL or -OL	Overloaded input or display. Input exceeds specifications. (Refer to table 1.)	Check input voltage or current. Must be within 0-10 Vdc or 0-20 mA.
-----	Internal analog-to-digital converter error.	Turn power off, wait at least 25 seconds, then turn power on again. If problem persists, return the unit by following the instructions on the back cover of this manual.

Table 3. Operating Error Messages

Message	During Normal Operation	
	Cause	Cure
OL or -OL	Input exceeds maximum specifications, or display is beyond -999 or 9999	Check input voltage or current for overrange condition or open circuit.
-----	Internal analog-to-digital converter error.	Turn power off, wait at least 25 seconds, then turn power on again. If problem persists, return the unit by following the instructions on the back cover of this manual.

NOTES

RETURN PROCEDURES

To return equipment to Moore Industries for repair, follow these four steps:

1. Call Moore Industries and request a Returned Material Authorization (RMA) number.

Warranty Repair –

If you are unsure if your unit is still under warranty, we can use the unit's serial number to verify the warranty status for you over the phone. Be sure to include the RMA number on all documentation.

Non-Warranty Repair –

If your unit is out of warranty, be prepared to give us a Purchase Order number when you call. In most cases, we will be able to quote you the repair costs at that time. The repair price you are quoted will be a "Not To Exceed" price, which means that the actual repair costs may be less than the quote. Be sure to include the RMA number on all documentation.

2. Provide us with the following documentation:
 - a) A note listing the symptoms that indicate the unit needs repair
 - b) Complete shipping information for return of the equipment after repair
 - c) The name and phone number of the person to contact if questions arise at the factory
3. Use sufficient packing material and carefully pack the equipment in a sturdy shipping container.
4. Ship the equipment to the Moore Industries location nearest you.

The returned equipment will be inspected and tested at the factory. A Moore Industries representative will contact the person designated on your documentation if more information is needed. The repaired equipment, or its replacement, will be returned to you in accordance with the shipping instructions furnished in your documentation.

WARRANTY DISCLAIMER

THE COMPANY MAKES NO EXPRESS, IMPLIED OR STATUTORY WARRANTIES (INCLUDING ANY WARRANTY OF MERCHANTABILITY OR OF FITNESS FOR A PARTICULAR PURPOSE) WITH RESPECT TO ANY GOODS OR SERVICES SOLD BY THE COMPANY. THE COMPANY DISCLAIMS ALL WARRANTIES ARISING FROM ANY COURSE OF DEALING OR TRADE USAGE, AND ANY BUYER OF GOODS OR SERVICES FROM THE COMPANY ACKNOWLEDGES THAT THERE ARE NO WARRANTIES IMPLIED BY CUSTOM OR USAGE IN THE TRADE OF THE BUYER AND OF THE COMPANY, AND THAT ANY PRIOR DEALINGS OF THE BUYER WITH THE COMPANY DO NOT IMPLY THAT THE COMPANY WARRANTS THE GOODS OR SERVICES IN ANY WAY.

ANY BUYER OF GOODS OR SERVICES FROM THE COMPANY AGREES WITH THE COMPANY THAT THE SOLE AND EXCLUSIVE REMEDIES FOR BREACH OF ANY WARRANTY CONCERNING THE GOODS OR SERVICES SHALL BE FOR THE COMPANY, AT ITS OPTION, TO REPAIR OR REPLACE THE GOODS OR SERVICES OR REFUND THE PURCHASE PRICE. THE COMPANY SHALL IN NO EVENT BE LIABLE FOR ANY CONSEQUENTIAL OR INCIDENTAL DAMAGES EVEN IF THE COMPANY FAILS IN ANY ATTEMPT TO REMEDY DEFECTS IN THE GOODS OR SERVICES, BUT IN SUCH CASE THE BUYER SHALL BE ENTITLED TO NO MORE THAN A REFUND OF ALL MONIES PAID TO THE COMPANY BY THE BUYER FOR PURCHASE OF THE GOODS OR SERVICES.

ANY CAUSE OF ACTION FOR BREACH OF ANY WARRANTY BY THE COMPANY SHALL BE BARRED UNLESS THE COMPANY RECEIVES FROM THE BUYER A WRITTEN NOTICE OF THE ALLEGED DEFECT OR BREACH WITHIN TEN DAYS FROM THE EARLIEST DATE ON WHICH THE BUYER COULD REASONABLY HAVE DISCOVERED THE ALLEGED DEFECT OR BREACH, AND NO ACTION FOR THE BREACH OF ANY WARRANTY SHALL BE COMMENCED BY THE BUYER ANY LATER THAN TWELVE MONTHS FROM THE EARLIEST DATE ON WHICH THE BUYER COULD REASONABLY HAVE DISCOVERED THE ALLEGED DEFECT OR BREACH.

RETURN POLICY

For a period of thirty-six (36) months from the date of shipment, and under normal conditions of use and service, Moore Industries ("The Company") will at its option replace, repair or refund the purchase price for any of its manufactured products found, upon return to the Company (transportation charges prepaid and otherwise in accordance with the return procedures established by The Company), to be defective in material or workmanship. This policy extends to the original Buyer only and not to Buyer's customers or the users of Buyer's products, unless Buyer is an engineering contractor in which case the policy shall extend to Buyer's immediate customer only. This policy shall not apply if the product has been subject to alteration, misuse, accident, neglect or improper application, installation, or operation. THE COMPANY SHALL IN NO EVENT BE LIABLE FOR ANY INCIDENTAL OR CONSEQUENTIAL DAMAGES.



WORLDWIDE • www.miinet.com

United States • info@miinet.com Tel: (818) 894-7111 • FAX: (818) 891-2816	Belgium • info@mooreind.be Tel: 03/448.10.18 • FAX: 03/440.17.97	China • sales@mooreind.sh.cn Tel: 86-21-62491499 • FAX: 86-21-62490635
Australia • sales@mooreind.com.au Tel: (02) 8536-7200 • FAX: (02) 9525-7296	The Netherlands • sales@mooreind.nl Tel: (0)344-617971 • FAX: (0)344-615920	United Kingdom • sales@mooreind.com Tel: 01293 514488 • FAX: 01293 536852